

PLATINUM SMART-HEAT™ GAS

The Platinum Smart-Heat™ Gas heater series spreads heat and comfort evenly in all areas, with a soft and soothing red glow. Built with pure premium materials and designed with elegance, there is no compromise on performance, reliability and beauty.



500 SERIES



300 SERIES

SPECIFICATIONS

Reference the specification guide below to help you select the correct solution for your needs.

MODEL NUMBER	300 SERIES	500 SERIES
FUEL TYPE	LPG NG	LPG NG
COLOUR	BLACK	BLACK
HEAT AREA	12M ²	20M ²
MINIMUM FLOOR CLEARANCE	2500MM	2500MM
OUTPUT	25 MJ	42MJ
MOUNTING OPTIONS		
CEILING MOUNT	✓	✓
WALL MOUNT	✓	✓
RECESSED FLUSH MOUNT	-	-
CEILING POLE MOUNT	✓	✓
FREESTANDING	-	-
CONTROL OPTIONS		
ON OFF	✓	✓
DIMMER	-	-
MASTER REMOTE	-	-

DIMENSIONS

With a wide range of sizes available, find the ideal heater to suit your outdoor space.

FRONT PROFILE

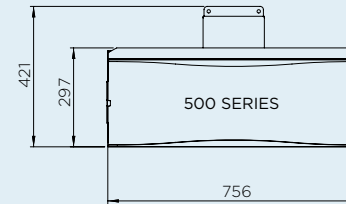

+ HEAT DEFLECTOR

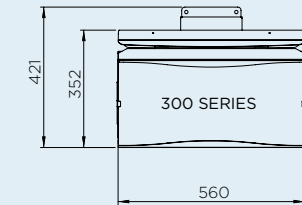
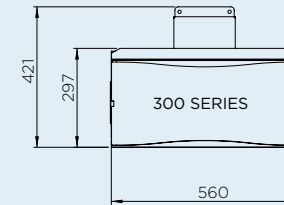
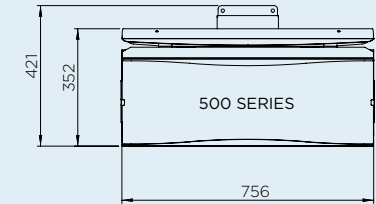

SIDE PROFILE

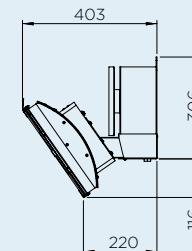

+ HEAT DEFLECTOR

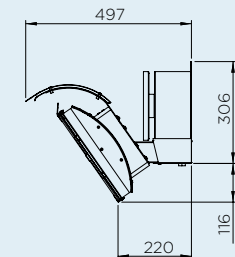

Measurements displayed within this document are minimum requirements for installation. Bromic takes no responsibility for incorrect or non-compliant installations. All measurement in this document are displayed in mm.

MOUNT OPTIONS

With a wide array of mounting options, Bromic offers solutions to compliment any décor and provide functionality for ambiance and comfort.

WALL MOUNT

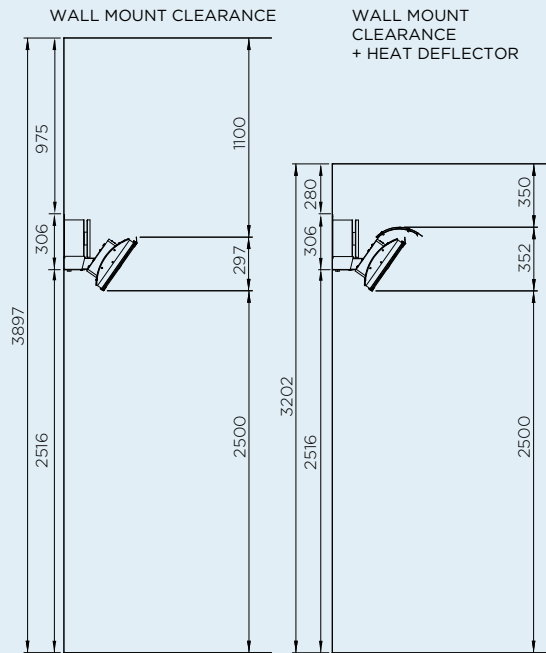

CEILING MOUNT

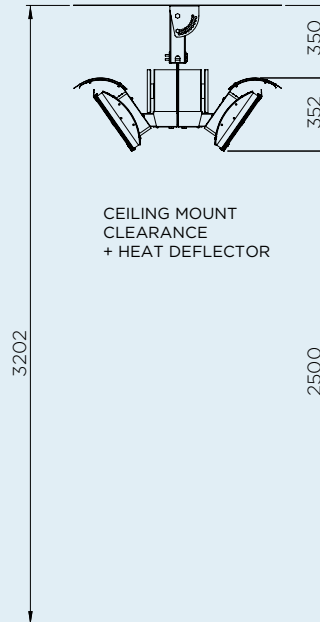

WALL BRACKET

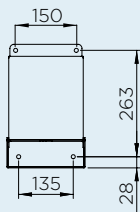

HEATING REACH

Creating ideal comfort levels, Bromic heaters offer a variety of heat distribution options to suit your outdoor heating needs.

500 SERIES

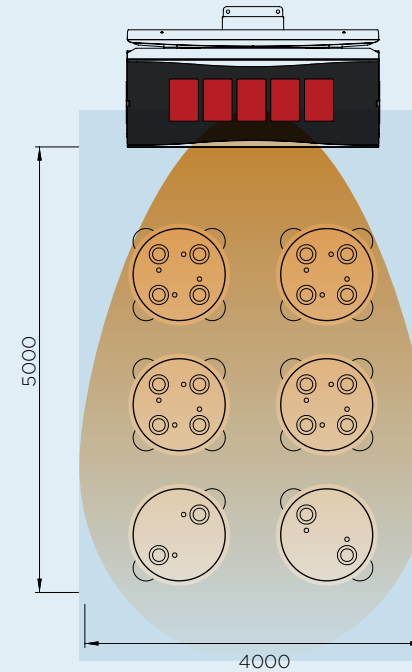

HEATING APPROXIMATELY 20M²
42MJ HEATING POWER

300 SERIES

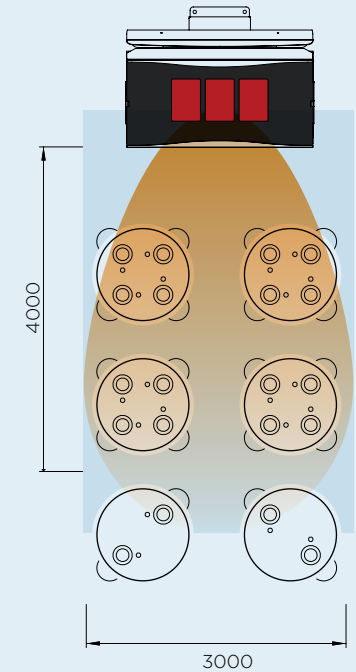

HEATING APPROXIMATELY 12M²
25MJ HEATING POWER

CONTROL OPTIONS



ON | OFF CONTROL



MASTER REMOTE



EXTEND YOUR COMFORT OUTDOORS
WITH THE SUPERIOR HEAT AND
AWARD-WINNING DESIGN OF OUR
SMART-HEAT™ OUTDOOR HEATERS.

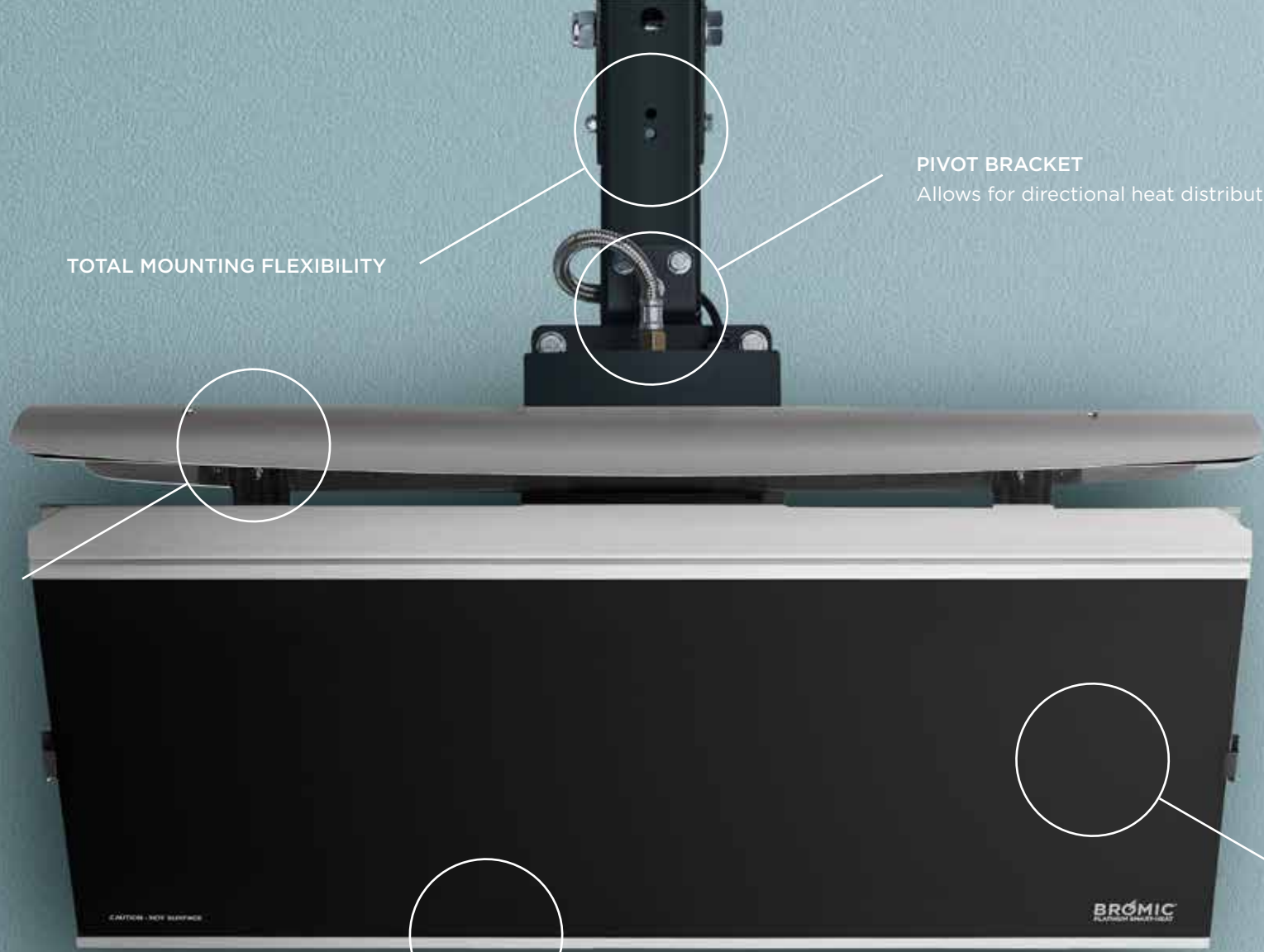

PIVOT BRACKET
Allows for directional heat distribution

TOTAL MOUNTING FLEXIBILITY

PATENTED PERFORMANCE
Superior wind resistance

UNIQUE DESIGN
Ceramic fascia enables even heat distribution

PREMIUM CONSTRUCTION
High performing stainless steel for long lasting and durable use

BROMIC.COM/HEAT

ASIA PACIFIC | NORTH AMERICA | EUROPE

Bromic pursues a policy of continuing improvement in design and performance of its products. The right is therefore reserved to vary specifications without notice.
03.2021