

TUNGSTEN SMART-HEAT™ GAS

Our Tungsten Smart-Heat™ Gas heater has a durable, soft flowing curved fascia and engineered body, which produces formidable heat to create a truly comfortable outdoor space. Its easy pivot arm allows for greater positioning and directional heat control. This heater also has a range of accessories available to provide versatility in mounting & controller options.

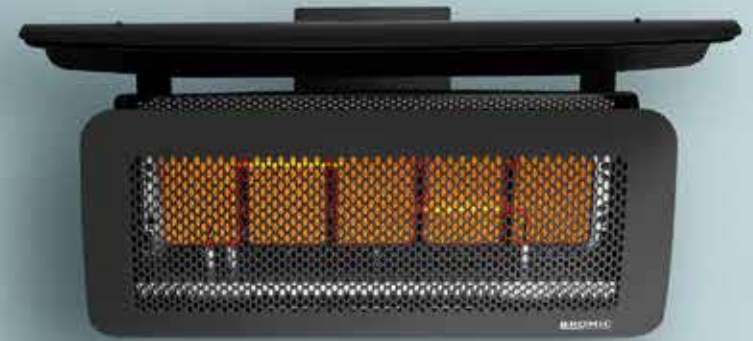

500 SERIES



300 SERIES

SPECIFICATIONS

Reference the specification guide below to help you select the correct solution for your needs.

MODEL NUMBER	300 SERIES	500 SERIES
FUEL TYPE	LPG NG	LPG NG
COLOUR	BLACK	BLACK
HEAT AREA	12 M ²	20 M ²
MINIMUM FLOOR CLEARANCE	2500MM	2500MM
OUTPUT	25MJ	42MJ
MOUNTING OPTIONS		
CEILING MOUNT	✓	✓
WALL MOUNT	✓	✓
RECESSED FLUSH MOUNT	-	-
CEILING POLE MOUNT	✓	✓
FREESTANDING	-	-
CONTROL OPTIONS		
ON OFF	✓	✓
DIMMER	-	-
MASTER REMOTE	-	-

DIMENSIONS

With a wide range of sizes available, find the ideal heater to suit your outdoor space.

FRONT PROFILE

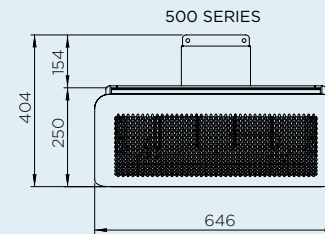

+ HEAT DEFLECTOR

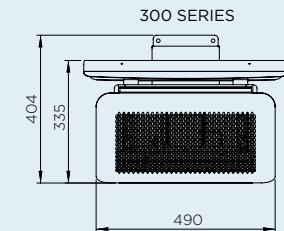
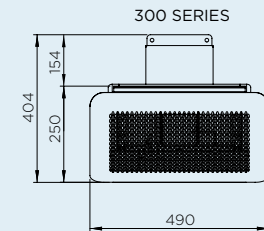
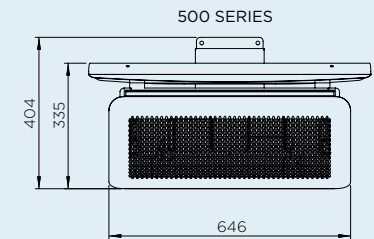

SIDE PROFILE

+ HEAT DEFLECTOR

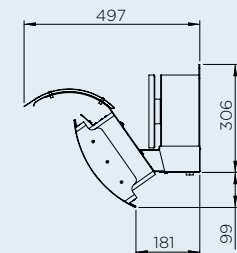
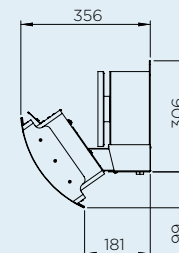

Measurements displayed within this catalogue are minimum requirements for installation. Bromic takes no responsibility for incorrect or non-compliant installations. All measurement in this catalogue are displayed in mm.

MOUNT OPTIONS

With a wide array of mounting options, Bromic offers solutions to compliment any décor and provide functionality for ambiance and comfort.

WALL MOUNT

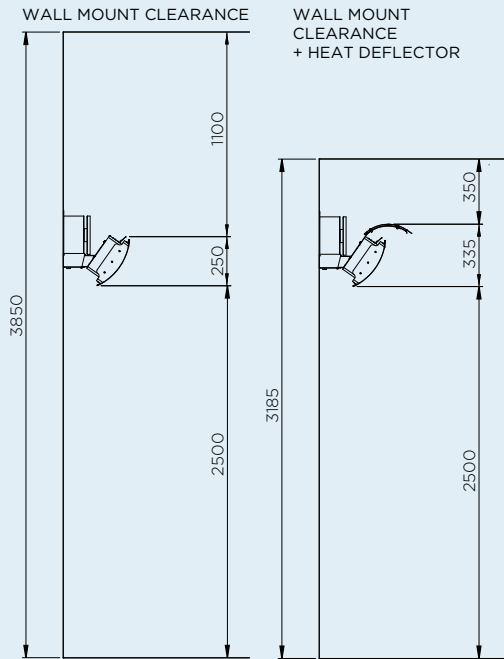

CEILING MOUNT

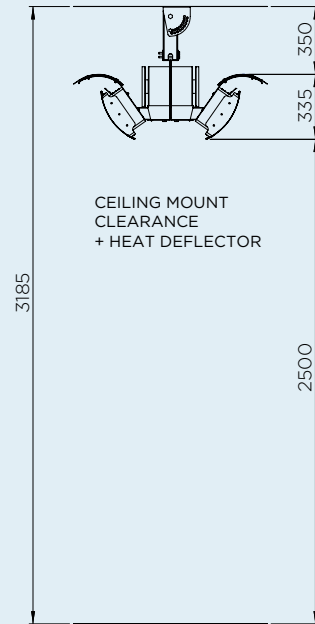

WALL BRACKET

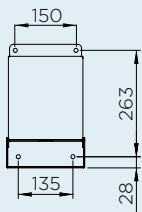

HEATING REACH

Creating ideal comfort levels, Bromic heaters offer a variety of heat distribution options to suit your outdoor heating needs.

500 SERIES

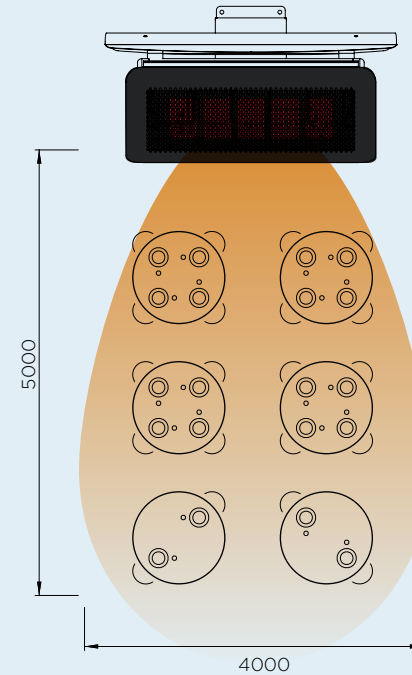

HEATING APPROXIMATELY 20M²
42 MJ HEATING POWER

300 SERIES

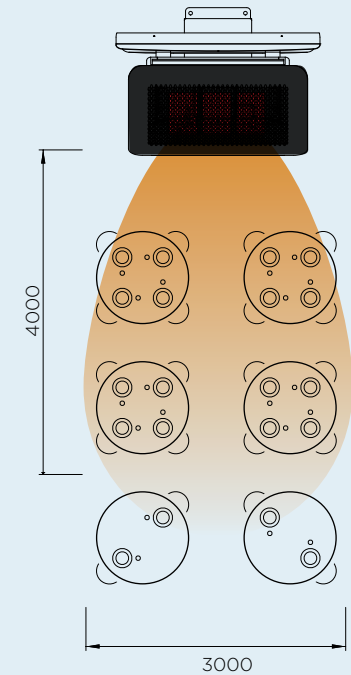

HEATING APPROXIMATELY 12M²
25 MJ HEATING POWER

CONTROL OPTIONS



ON | OFF CONTROL



MASTER REMOTE



EXTEND YOUR COMFORT OUTDOORS
WITH THE SUPERIOR HEAT AND
AWARD-WINNING DESIGN OF OUR
SMART-HEAT™ OUTDOOR HEATERS.

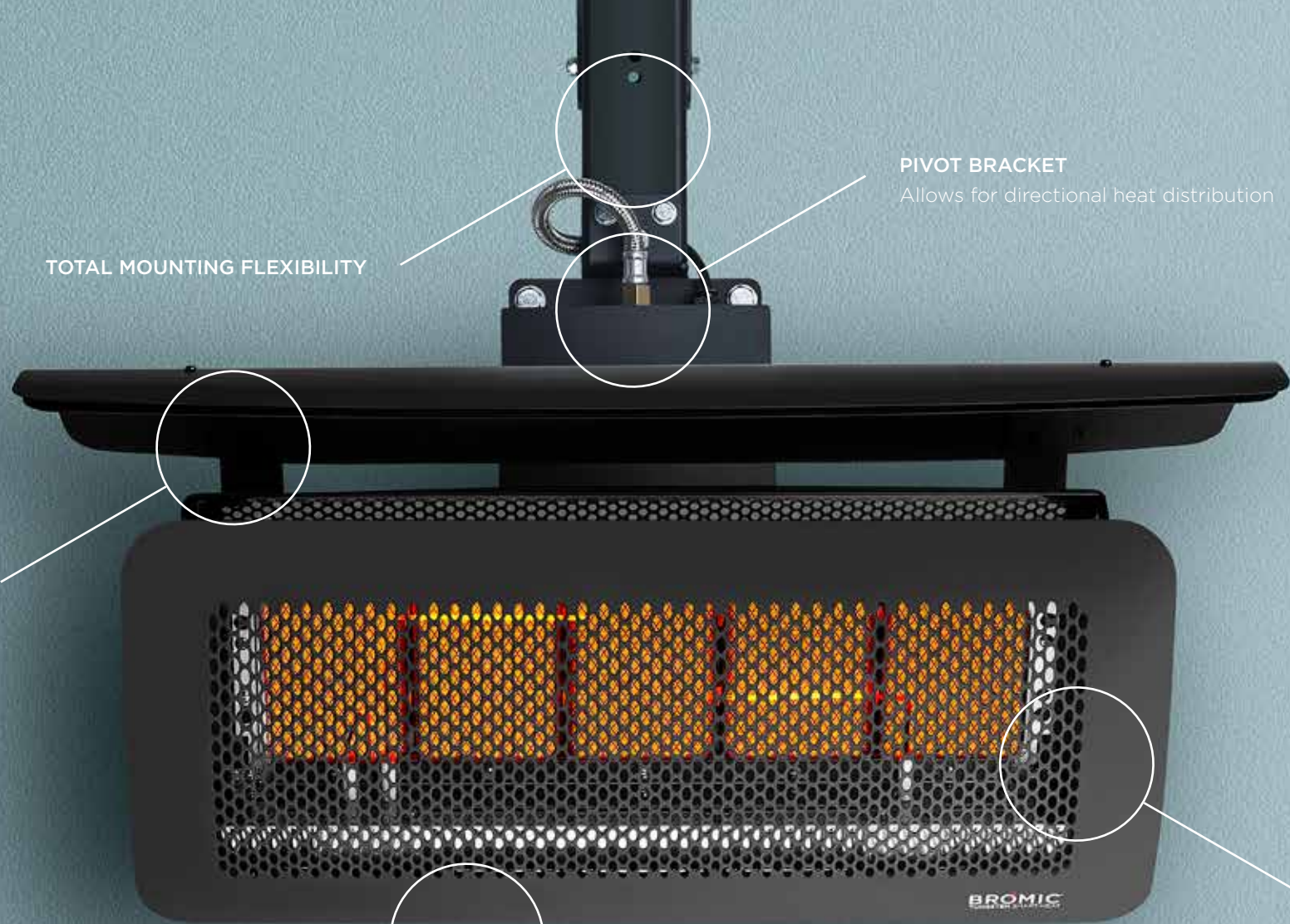

TOTAL MOUNTING FLEXIBILITY

PIVOT BRACKET
Allows for directional heat distribution

PATENTED PERFORMANCE
Superior wind resistance

HIGH PERFORMANCE CONSTRUCTION
Matte black stainless-steel body

UNIQUE DESIGN
Honeycomb fascia enables precise heat distribution

BROMIC.COM/HEAT

ASIA PACIFIC | NORTH AMERICA | EUROPE

Bromic pursues a policy of continuing improvement in design and performance of its products. The right is therefore reserved to vary specifications without notice.
10.2020