



Exterior awning

## markilux 870 tracfix

The exterior awning for medium-sized areas with a round cassette.



reddot design award  
winner 2017



[markilux.com](http://markilux.com)

**markilux**  
safe timeless beautiful

01  
02  
03  
04  
05  
06  
07  
08  
09  
10  
11  
12  
13  
14  
15  
16  
17  
18  
19  
20

## Product characteristics

Wind resistance class 3  
Beaufort 6 → 38–48 km/h → 10.5–13.4 m/s → 24–30 mph



1 side view track-only fixture

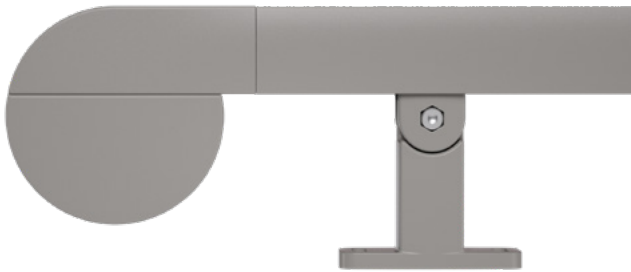

2 front profile finishes flush with the end of the guide tracks

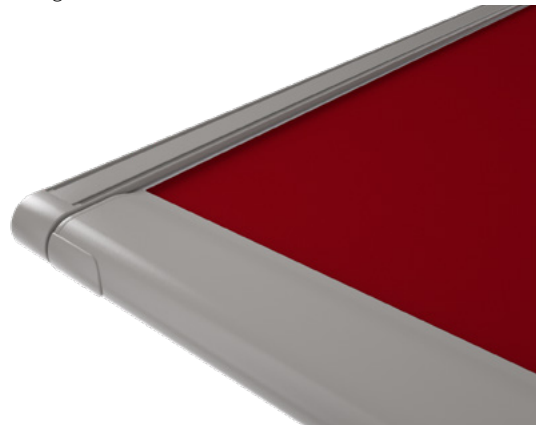

3 tracfix cover guidance – no gap between cover and guide track

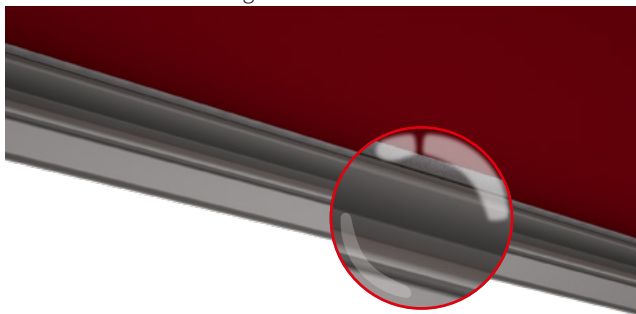

## Product characteristics

### Description

- exterior awning for conservatories and glass canopies. One awning can shade an area of up to 16 m<sup>2</sup>.

### Special features

- fully encompassing cassette that protects the cover perfectly
- the tried and tested tensioning system – with drive belts and integrated gas pistons – delivers optimum cover tension in any phase of extension
- as standard with tracfix, the continuous lateral cover guidance system that leaves no gap between the cover and guide tracks – gives improved wind stability and a cleaner appearance
- the broad range of brackets with patented clip-on system offers individual fixture solutions, from discrete to conspicuous

### Dimensions

- single unit: awning fixture width 60 cm – 450 cm in width, maximum extension 400 cm
- maximum dimensions, awning fixture width × extension: 450 cm × 400 cm
- intermediate sizes are available

### Roller tube and lateral bearings

- round roller tube Ø 85 mm with keyway, galvanised steel
- excellent stability, ensures near perfect cover performance even at the largest widths
- the roller tube bearing is made of stainless steel

### Awning profiles

- extruded aluminium, in façade quality, powder coated
- cassette profile in two pieces, round, Ø 130 mm
- guide tracks angular, rounded edges, width × height 52 mm × 52 mm
- front profile rounded at the front, depth × height 110 mm × 52 mm

### Side caps

- the cassette end caps are made of die-cast aluminium, in two parts, powder coated
- the front profile end caps are made of high-quality plastic, powder coated

### Fixture brackets

- extruded aluminium, powder coated
- cassette is self-supporting on guide tracks
- brackets for the guide tracks: stand-off brackets, reveal fixture, flat track brackets for lateral fixture
- standard bracket heights: 105 mm / 145 mm / 100–500 mm (bespoke heights can be ordered)
- other accessories are available

01 **Frame colours**02 **markilux frame colours without surcharge**

03 traffic white RAL 9016



04 metallic aluminium RAL 9006

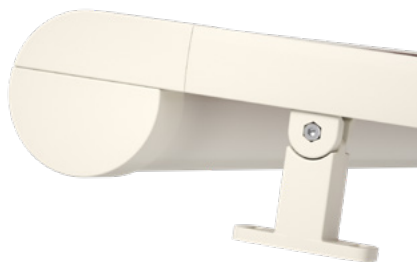

05 grey brown, similar to RAL 8019

06 off-white textured finish, 5233 <sup>1)</sup>07 stone grey metallic, 5215 <sup>1)</sup>08 anthracite metallic, 5204 <sup>1)</sup>09 Havana brown textured finish, 5229 <sup>1)</sup>

17

18

19

20

**Non-standard powder-coated finish**

Bespoke frame colours at a surcharge – matt, metallic and pearl finishes as well as other colour ranges (DB, Tiger etc.) on request. All frame colours are available at a surcharge with enhanced corrosion protection.

**1)** textured finish

Colours may differ slightly from those depicted in both hue and finish.

# Dimensions and configuration options

Single unit

Order dimensions	Awning fixture width							Minimum fixture width	
	150	200	250	300	350	400	450	Hard-wired motor	Radio-controlled motor
	60	151	201	251	301	351	401		
	150	200	250	300	350	400	450		
Overall width	+ 5,4								
H	150							107 <sup>1)</sup>	107 <sup>1)</sup>
	200								
	250								
	300								
	350								
	400								

dimensions in cm

- 1) = from an extension of 281 cm
- H = extension
-  = 4 brackets
-  = 6 brackets
-  = 6 brackets, 1 cover support tube

### Operation

	standard	optional
crank handle	—	—
hard-wired motor	✓	—
silentec motor (optionally with an external io / RTS receiver)	—	—
radio-controlled motor io, 868 MHz	—	✓
radio-controlled motor RTS, 433 MHz	—	✓
radio-controlled motor RTS, 433 MHz with manual override	—	—

### Coupled Awning

not available

### Optional accessories

automatic controls (light, wind, rain)

**N.B!** Important background information can be found in the chapter "Optional Accessories".

### Shadeplus / drop valance

not available

Awning cover	fabric range no.	standard	optional	awning fixture width	extension	cover manufacture
<b>sunvas</b>	301.. / 309..-315..	✓	—	≤ 400	≤ 400	LN
<b>sunsilk</b>	324.. / 325.. / 328.. / 369..	✓	—	≤ 400	≤ 400	LN
<b>perfortex</b>	331.. / 332..	✓	—	≤ 400	≤ 400	LN
<b>sunvas (250 cm)</b>	31008, -09, -13, -16, -18, -25, 27, -28, -31, -36, -37, -57, -58, 31109, -14, -17	✓	—	≤ 250		N
				≤ 400	≤ 243	N
<b>transolair</b>	338..	—	✓	≤ 400	≥ 244 ≤ 400	QN
<b>transolair (120 cm)</b>	339..	—	✓	≤ 400	≤ 400	LN
				≤ 320		N
<b>sunvas (320 cm)</b>	31008, -09	✓	—	≤ 400	≤ 313	N
				≤ 400	≥ 314	QN
<b>vuscreen Alu</b>	317..	—	✓	≤ 400	< 244	N
				≤ 400	≥ 244 ≤ 400	QN
				≥ 401	≤ 250	N
<b>Soltis Perform 92</b>	92-20..	—	✓	≤ 185	≤ 300	N
				≤ 400	≤ 194	N
				≥ 186 ≤ 400	≥ 195 ≤ 300	QN
<b>perla</b>	370..	—	✓	≤ 450	≤ 400	LN
<b>perla FR</b>	374.. / 375..	—	—			

dimensions in cm

- N = seamless
- LN = vertical seam(s), panel width usually 120 cm
- QN = horizontal seam(s)

## Fixtures, fittings and accessories

01  
02  
03  
04  
05  
06  
07  
08  
09  
10  
11  
12  
13  
14  
15  
16  
17  
18  
19  
20

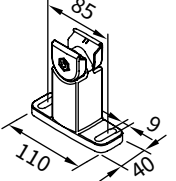
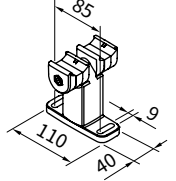
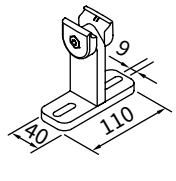
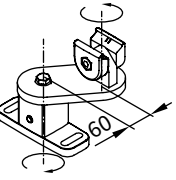
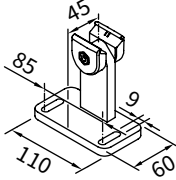
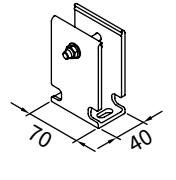
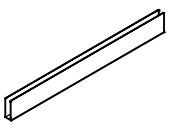
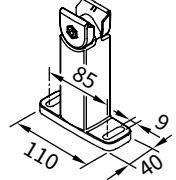
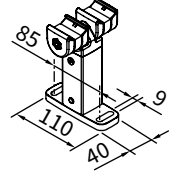
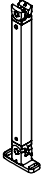
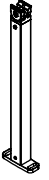
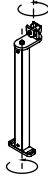
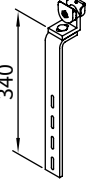
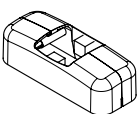
 <p>track bracket with adjustable head 100 mm</p> <p><b>76046.</b></p>	 <p>double track bracket with adjustable head central bracket for 2 single units next to one another 100 mm</p> <p><b>73634.</b></p>	 <p>track bracket for conservatory transom fixture 100 mm</p> <p><b>76055.</b></p>
 <p>universal track bracket 100 mm</p> <p><b>76054.</b></p>	 <p>track bracket with adapter plate 100 mm</p> <p><b>76199.</b></p>	 <p>track bracket for track-only fixture 100 mm</p> <p><b>76017.</b></p>
 <p>track bracket for track-only fixture by the metre, undrilled 100 mm maximum length: 6 m</p> <p><b>76013.</b></p>	 <p>track bracket with adjustable head 140 mm</p> <p><b>76048.</b></p>	 <p>double track bracket with adjustable head central bracket for 2 single units next to one another 140 mm</p> <p><b>73636.</b></p>
 <p>track bracket top and bottom with adjustable head 200-500 mm</p> <p><b>76045.</b></p>	 <p>track bracket with adjustable head 140-500 mm</p> <p><b>76047.</b></p>	 <p>universal track bracket with adjustable head 140-500 mm</p> <p><b>76053.</b></p>
 <p>flat track bracket with adjustable head for lateral guide track fixture</p> <p><b>76049.</b></p>	 <p>cover cap for square track bracket standard accessory for bracket</p> <p><b>2 × 76718.</b></p>	

dimensions in mm

## Fixtures, fittings and accessories

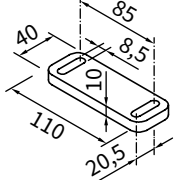

spacer plate  
for track bracket

110 × 40 × 10 mm

**78570.**

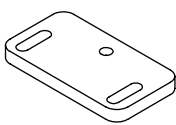

adapter plate  
for track bracket

110 × 60 × 10 mm

**78158.**

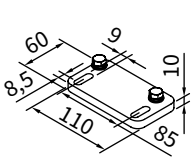

adapter plate  
for track bracket

110 × 60 × 10 mm

**78165.**

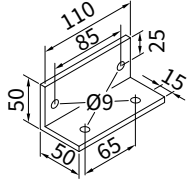

angled mounting bracket

**76098.**

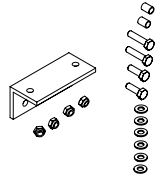

angled mounting bracket  
76098. including coupling  
bolts

**76099.**

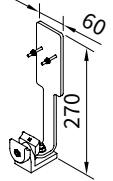

fixture bracket for sun  
and/or wind and/or rain  
sensor

**76050.**

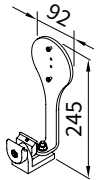

bracket sun and/or wind  
sensor io

**76723.**

01  
02  
03  
04  
05  
06  
07  
08  
09  
10  
11  
12  
13  
14  
15  
16  
**17**  
18  
19  
20

dimensions in mm

01 **Fixture types**

02

03

**21**

Clearance 105 mm

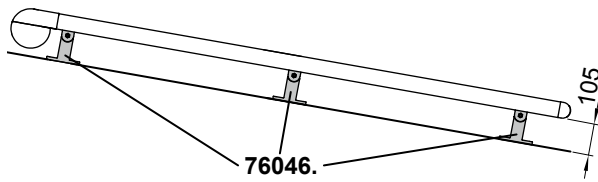

05

06

07

**22**

Clearance 145 mm

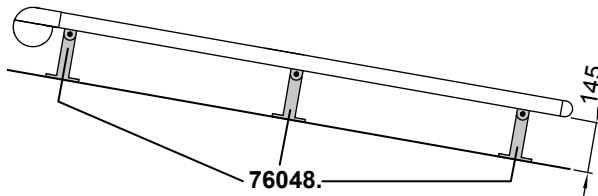

08

09

11

**30**

Flat track bracket

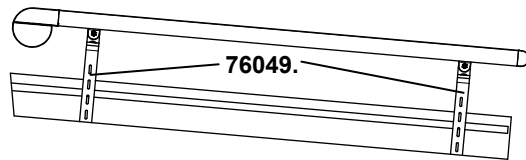

**Individual choice of brackets:**  
see "Fixtures, fittings and accessories". When extension > 300 cm always with 3 brackets per guide track.

13

14

Overview of fixture dimensions

15

16

**17**

18

19

20

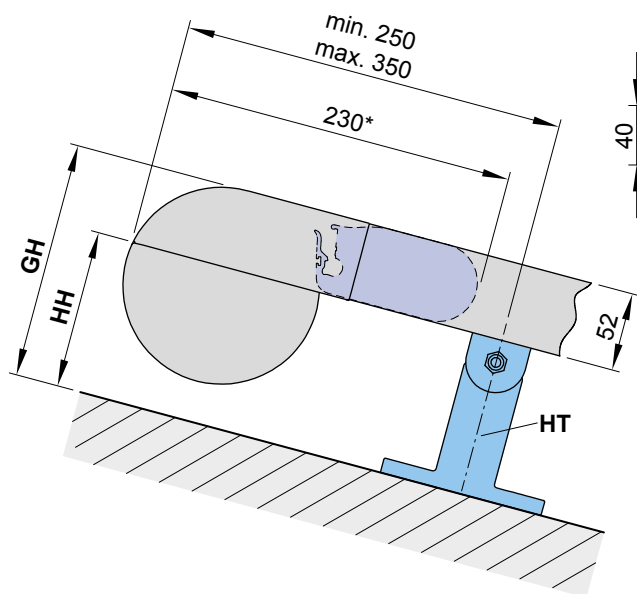

Fixture type 21, 22

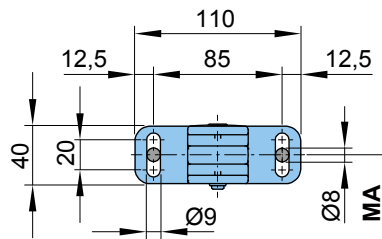

Fixture type 30

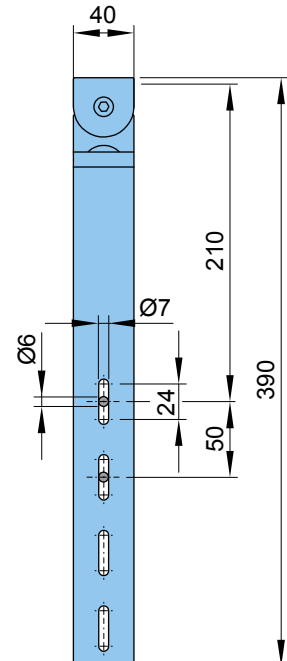

	Fixture type 21	Fixture type 22	Fixture type 30
HT	= bracket <b>76046.</b>	<b>76048.</b>	<b>76049.</b>
HH	= bracket height 105	145	approx. 195–335
GH	= overall height 157	197	approx. 247–387

MA = *order dimension* = awning fixture width = fixture width

\* = unit depth when retracted

dimensions in mm



# Overview of fixture dimensions

Single unit

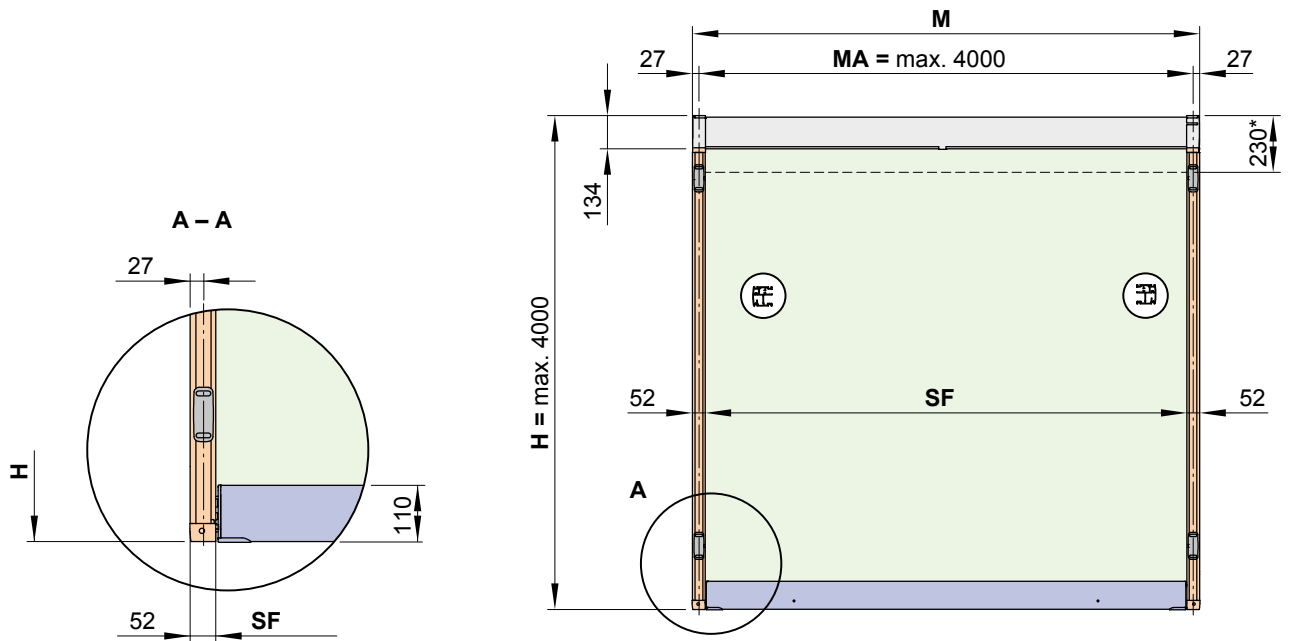

Two single units - fixture via double track brackets

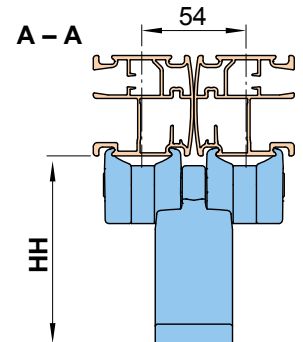
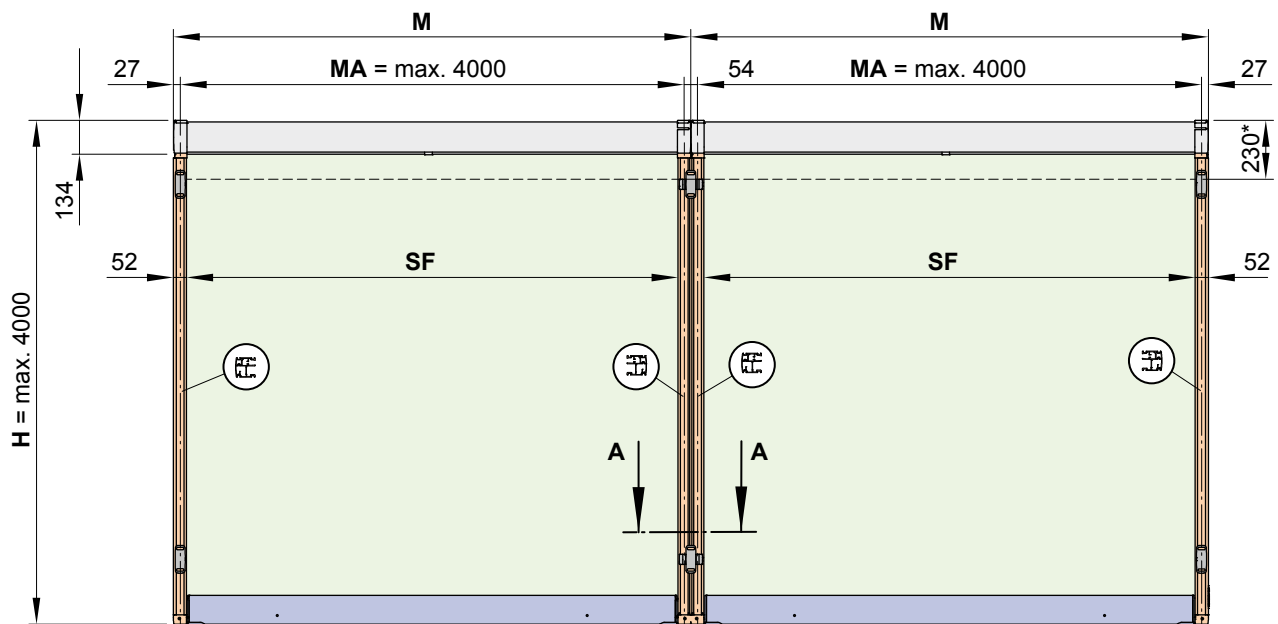

- \* = unit depth when retracted
- H = *order dimension* = extension
- HH = bracket height
- M = overall awning width
- MA = *order dimension* = awning fixture width = fixture width
- SF = visible cover area

dimensions in mm

01  
02  
03  
04  
05  
06  
07  
08  
09  
10  
11  
12  
13  
14  
15  
16  
17  
18  
19  
20

# Dimension overview fixture types 21, 22

## Fixtures, fittings and accessories

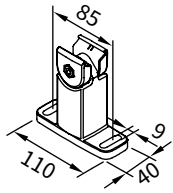

track bracket  
with adjustable head  
100 mm

**76046.**

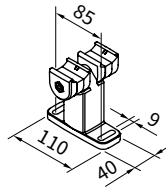

double track bracket  
with adjustable head  
central bracket for 2  
single units next to one  
another  
100 mm

**73634.**

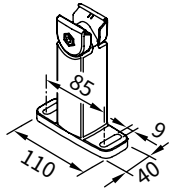

track bracket  
with adjustable head  
140 mm

**76048.**

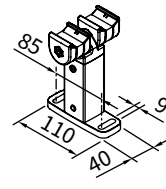

double track bracket  
with adjustable head  
central bracket for 2  
single units next to one  
another  
140 mm

**73636.**

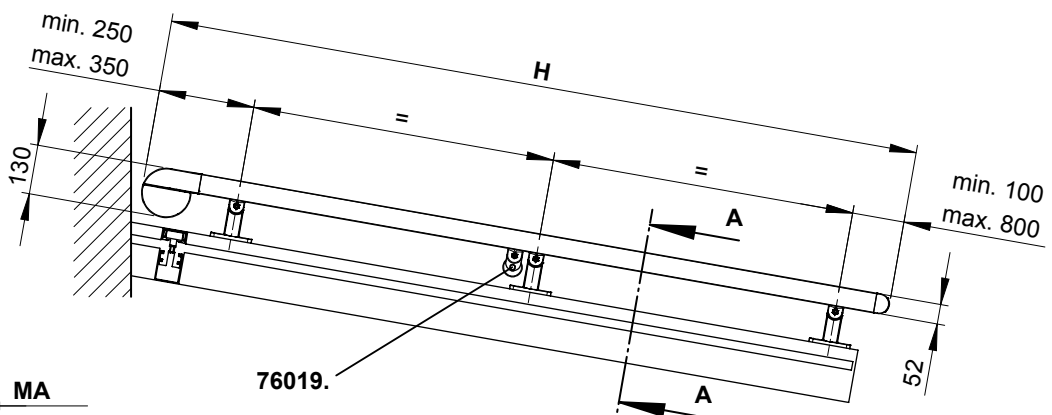

**76019.**

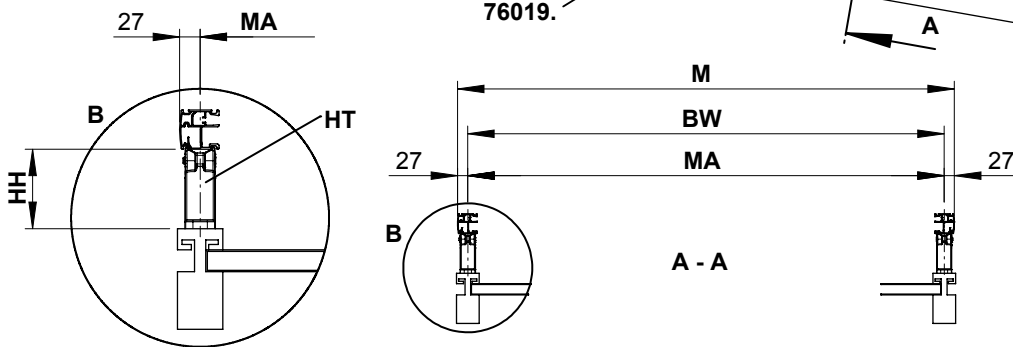

**76019.** = bracket for cover support tube

**BW** = width between fixture points  
on the conservatory

**H** = *order dimension* = extension

**HH** = bracket height

**HT** = bracket

**M** = overall awning width

**MA** = *order dimension* = awning fixture width = fixture width      dimensions in mm

# Dimension overview fixture type 30

Fixtures, fittings and accessories

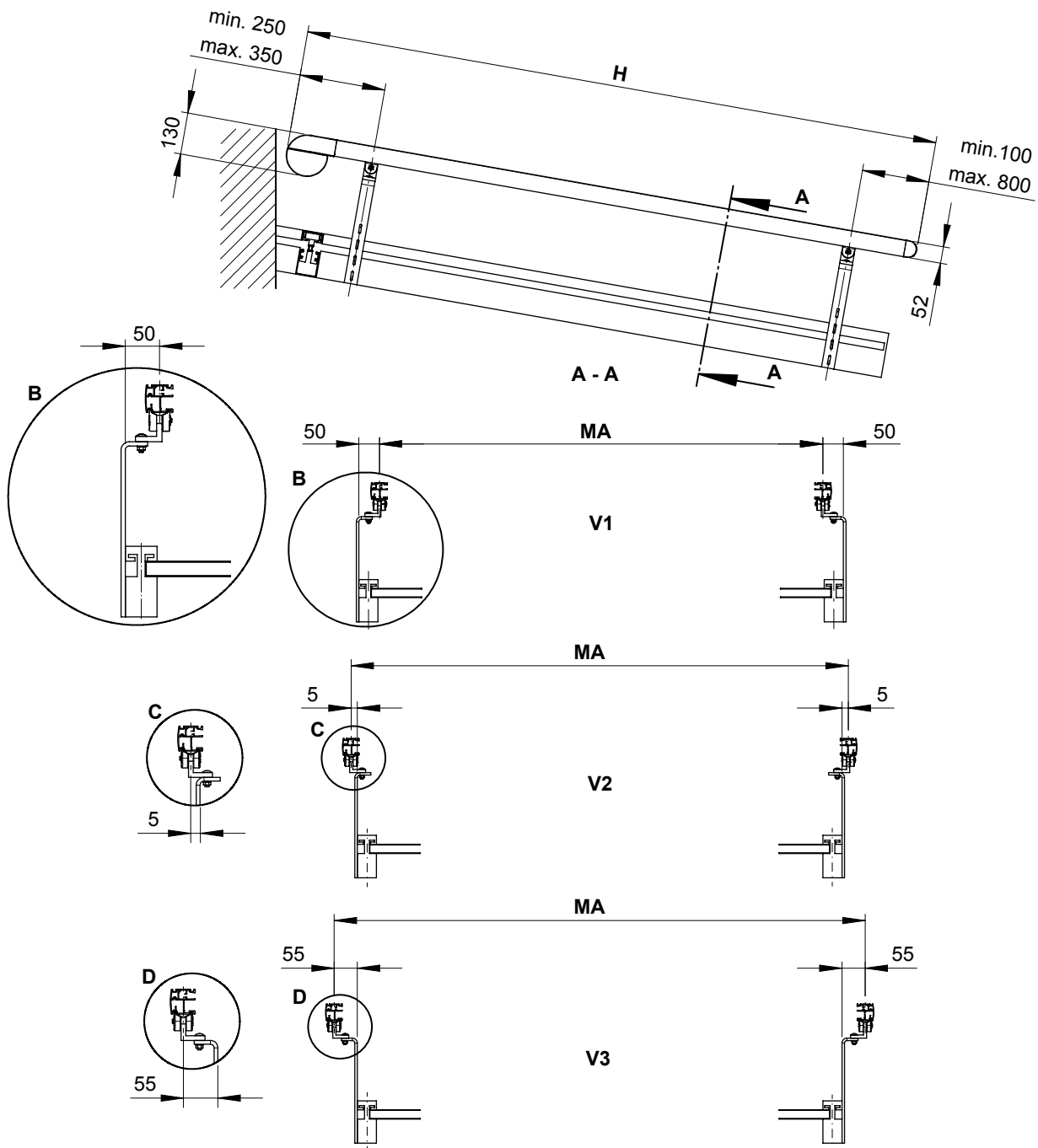
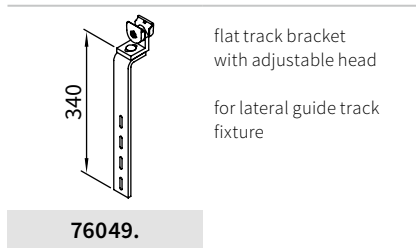

- H = order dimension = extension
- MA = order dimension = awning fixture width = fixture width
- V1, V2, V3 = version

dimensions in mm

01  
02  
03  
04  
05  
06  
07  
08  
09  
10  
11  
12  
13  
14  
15  
16  
**17**  
18  
19  
20

# Dimension overview eaves fixture with additional bracket fitting

Fixtures, fittings and accessories

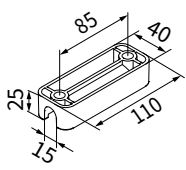

track bracket accessory for track fixture directly on top of the glazing bars (width 14 mm)

76804.

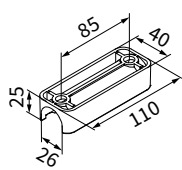

track bracket accessory for track fixture directly on top of the glazing bars (width 25 mm)

76805.

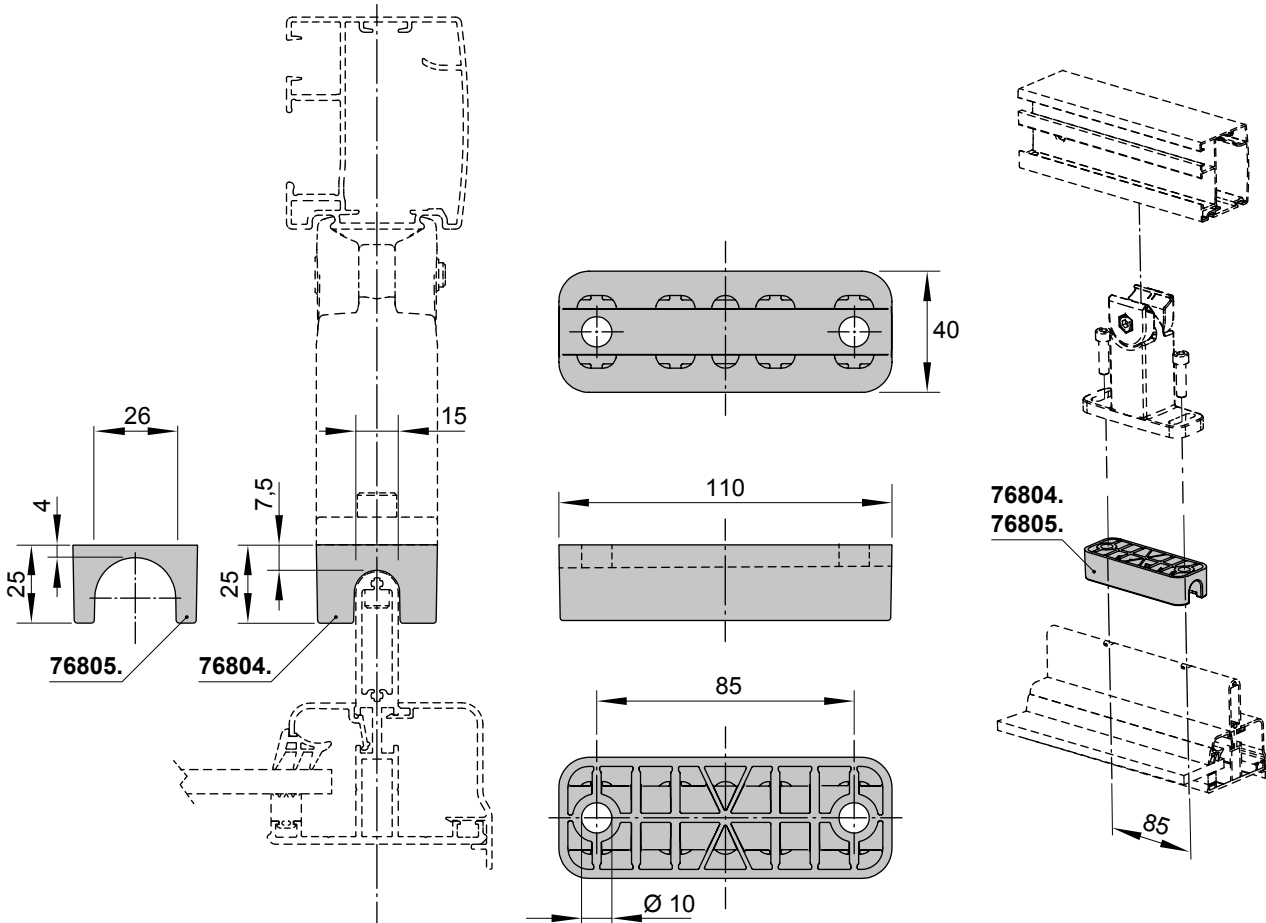

dimensions in mm

### Motor cable exit point

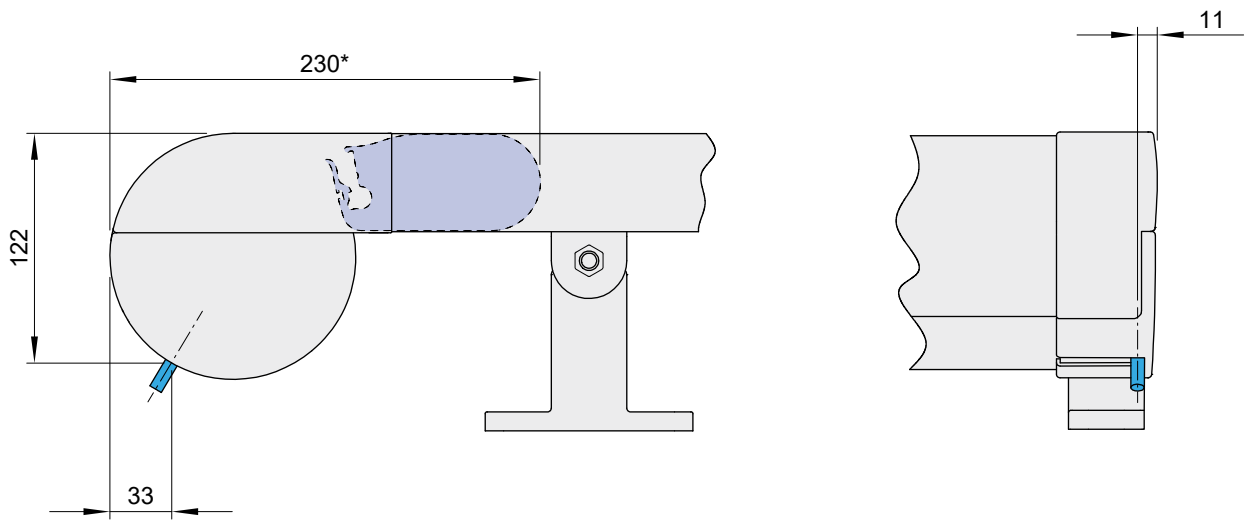

- 01
- 02
- 03
- 04
- 05
- 06
- 07
- 08
- 09
- 10
- 11
- 12
- 13
- 14
- 15
- 16
- 17**
- 18
- 19
- 20

\* = unit depth when retracted

dimensions in mm

01

02

03

04

05

06

07

08

09

10

11

12

13

14

15

16

**17**

18

19

20